

## 1. 产品特点 Product features

- 电流转换率(Current transfer ratio)  
CTR: Min. 20% at  $I_F = \pm 1\text{mA}$ ,  $V_{CE} = 5\text{V}$
- 输入与输出间高隔离电压(Viso=3750 V rms)  
High isolation voltage between inputs and output (Viso=3750 V rms)
- 符合无卤素(溴<900ppm, 氯<900ppm, 溴+氯<1500ppm)  
Compliance Halogen Free (Br < 900ppm, Cl < 900ppm, Br+Cl < 1500ppm)

## 2. 产品描述 Product Description

- KTP3H4光耦合器由两个反向并联的红外发射二极管和光电晶体管构成光电耦合器  
The KTP3H4 series devices consist of two infrared emitting diodes, connected in inverse parallel, optically coupled to a phototransistor detector with green compound
- 采用4引脚小外形SMD封装的器件  
They are packaged in a 4-pin small outline SMD package

## 3. 产品应用 Product Applications

- 交流线路监视器 AC line monitor
- 可编程控制器 Programmable controllers
- 电话线接口 Telephone line interface
- 未知极性直流传感器 Unknown polarity DC sensor

## 4. 功能图 Functional Diagram

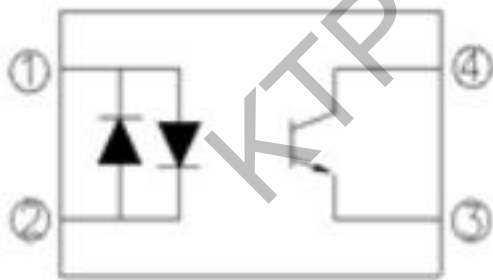

引脚配置 Pin Configuration

1. 阳极/阴极 Anode / Cathode
2. 阴极/阳极 Cathode / Anode
3. 发射极 Emitter
4. 集电极 Collector

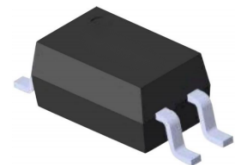

## 5. 光电特性 Electrical-Optical characteristics

• 最大限度额定值(温度=25°C) Absolute Maximum Ratings( $T_a=25^\circ\text{C}$ )

参数 Parameter		符号 Symbol	额定值 Rated Value	单位 Unit
输入 Input	正向电流 Forward current	$I_F$	$\pm 50$	mA
	峰值正向电流(10 $\mu\text{s}$ 脉冲) Peak forward current (10 $\mu\text{s}$ , pulse)	$I_F$	1	A
	功耗 Power Dissipation (注. $T_a=100^\circ\text{C}$ 以下功率不会下降) (No derating required up to $T_a=100^\circ\text{C}$ )	$P_D$	70	mW
输出 Output	功耗 Power dissipation 降额系数 ( $T_a=80^\circ\text{C}$ 以上) Derating factor (above $T_a=80^\circ\text{C}$ )	$P_C$	150	mW
			3.7	mW/ $^\circ\text{C}$
	集电极-发射极电压 Collector and emitter Voltage	$V_{CEO}$	80	V
	发射极-集电极电压 Emitter and Collector Voltage	$V_{ECO}$	6	V
总功耗 Total Consume Power		$P_{TOT}$	200	mW
隔离电压 *1 Isolation Voltage		$V_{iso}$	3750	Vrms
工作温度 Operating temperature		$T_{OPR}$	-55 to +100	$^\circ\text{C}$
储存温度 Storage temperature		$T_{STG}$	-55 to +125	$^\circ\text{C}$
焊接温度 *2 Soldering temperature		$T_{SOL}$	260	$^\circ\text{C}$

附注(Notes):

1\* 交流电源1分钟内, 相对湿度40~60%环境下, 隔离电压测试方法, 引脚1&2短接在一起, 引脚3&4短接在一起  
AC for 1 minute, 40~60%RH in this test, Pin 1,2 are shorted together, and 3,4 are shorted together

2\* 焊接时间为10秒 Soldering time is 10 seconds

## 6. 电气特性(T<sub>a</sub>=25°C,除非另有规定)

### Electrical Characteristics (T<sub>a</sub>=25°C unless specified otherwise)

参数 Parameter		符号 Symbol	最小值 Min.	规格值 Typ.	最大值 Max.	单位 Unit	条件 Condition
输入 In put	正向电压 Forward voltage	V <sub>F</sub>	-	1.2	1.4	V	I <sub>F</sub> =±20mA
	输入电容 Input capacitance	C <sub>in</sub>	-	50	250	pF	V=0, f=1kHz
输出 Out put	集电极暗电流 Collector-Emitter dark current	I <sub>CEO</sub>	-	-	100	nA	V <sub>CE</sub> =20V I <sub>F</sub> =0mA
	集电极-发射极击穿电压 Collector-Emitter breakdown voltage	V <sub>CEO</sub>	80	-	-	V	I <sub>C</sub> =0.1mA I <sub>F</sub> =0mA
	发射极-集电极击穿电压 Emitter-Collector breakdown voltage	V <sub>ECO</sub>	6	-	-	V	I <sub>E</sub> =0.01mA I <sub>F</sub> =0mA
传输特性 Transfer Characteristics	集电极-发射极饱和压降 Collector-Emitter saturation voltage	V <sub>CE(sat)</sub>	-	0.1	0.2	V	I <sub>F</sub> =±20mA I <sub>C</sub> =1mA
	隔离电阻 Isolation resistance	R <sub>iso</sub>	5×10 <sup>10</sup>	10 <sup>11</sup>	-	Ω	V <sub>IO</sub> =500Vdc 40~60% R.H.
	浮动电容 Floating capacitance	C <sub>f</sub>	-	0.6	1.0	pF	V <sub>IO</sub> =0V f=1MHz
	上升时间 Response Time (Rise)	t <sub>r</sub>	-	-	18	μs	V <sub>CE</sub> =2V, I <sub>C</sub> =2mA R <sub>L</sub> =100Ω
	下降时间 Response Time (Fall)	t <sub>f</sub>	-	-	18	μs	

• 温度T<sub>a</sub>=25°C下规格值 Typical values at T<sub>a</sub> = 25°C

• 传输特性等级表(T<sub>a</sub>=25°C, 除非另有规定)

Transfer Characteristics level table (T<sub>a</sub>=25°C unless specified otherwise)

参数 Parameter		符号 Symbol	最小值 Min.	规格值 Typ.*	最大值 Max.	单位 Unit	条件 Condition
电流传输比 Current Transferratio	KTP3H4	CTR	20	-	300	%	I <sub>F</sub> =±1mA V <sub>CE</sub> =5V
	KTP3H4A		50	-	150		
	KTP3H4B		100	-	300		

## 7. 可靠性试验 Reliability Test

序号 NO.	试验项目 Test Items	参考标准 Reference	试验条件 Test conditions	试验过程 Test process	试验数 Qty.(pcs)	允收水准 LTPD
1	温度循环 TC	JESD22-A104C	H:125±5°C 15min J5min L:-55±5°C 15min	300cycle	45	0/45
2	高温操作寿命 HTOL	JESD22-A108C	HTOL@100°±5C I <sub>F</sub> =10mA I <sub>C</sub> =10mA	168、500、 1000hrs	45	0/45
3	高温反向偏压 HTRB	JESD22-A108C	HTRB@125±5°C V <sub>ce</sub> =60V	168、500、 1000hrs	45	0/45
4	温湿度反向偏 压寿命试验 H3TRB	JESD22-A101- B	H3TRB@ 85±5°C、 85±5%RH V <sub>ce</sub> =60V	168、500、 1000hrs	45	0/45
5	压力锅 Autoclave	JESD22-A102- C	T <sub>a</sub> =121±5°C, 100±5%RH, 2atm	96hrs	45	0/45
6	高温储存 HTS	JESD22-A103C	HTS@125±5°C	168、500、 1000hrs	45	0/45
7	低温储存 LTS	JESD22-A119	LTS@-55±5°C	168、500、 1000hrs	45	0/45
8	耐锡热试验 RSH	JESD22-B106C	RSH@260±5°C	10sec*3times	45	0/45
9	可焊性 SD	JESD22-B102D	Pb-free@ 245±5°C	3sec*1times	22	0/22
备注 Remarks	<p>以上试验项目如与客户试验要求存在差异或者特殊客户特殊要求的,可根据实际情况按照客户的要求进行试 作,客户未要求依我司试验标准试作,不同产品使用不同电流进行测试</p> <p>All the tests should be performed according to customers' actual requirements, while difference of test standard or special requirements exist. Otherwise, all the tests are performed according to the standard listed above. Different current is applied to the tests of different product models</p>					

## 8. 特性曲线 Characteristic Curves

图1 正向电流与正向电压的关系

Fig.1 Forward Current vs Forward Voltage



图2 集电极电流vs正向电流曲线图

Fig.2 Collector Current vs. Forward Current Diagram

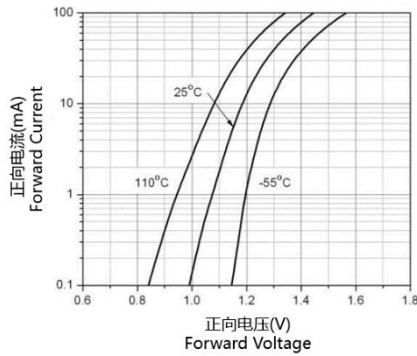

图3 电流转换比 vs正向电流曲线图

Fig.3 Current Transfer Ratio vs Forward Current Curve

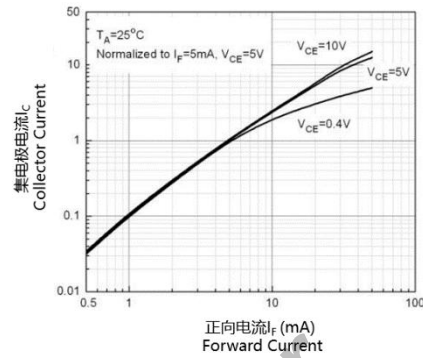

图4 集电极电流 vs环境温度曲线图

Fig.4 Collector Current vs. Ambient Temperature

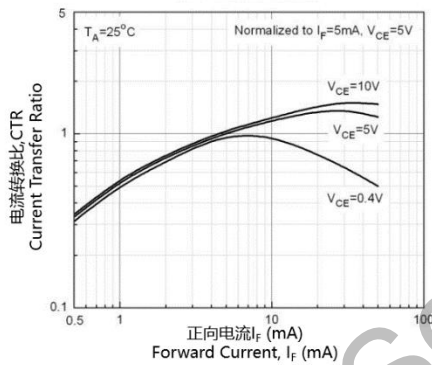

图5 电流转换比vs环境温度曲线图

Fig.5 Current Transfer Ratio vs Ambient Temperature Curve

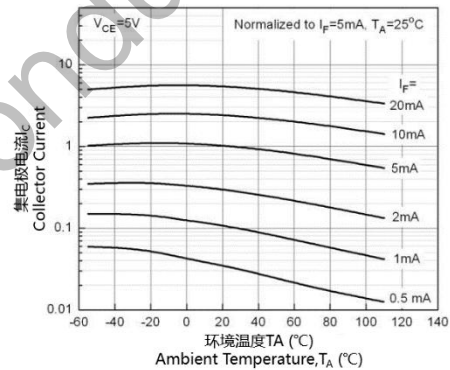

图6 集电极电流 vs 集电极-发射电压曲线图

Fig.6 Collector Current vs. Collector-Emission Voltage Diagram

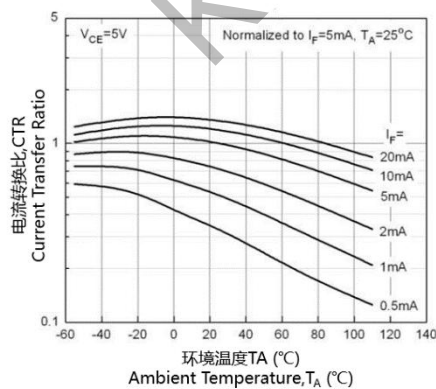

图7 集电极电流 vs集电极-发射电压曲线图

Fig.7 Collector Current vs. Collector-Emission Voltage Diagram

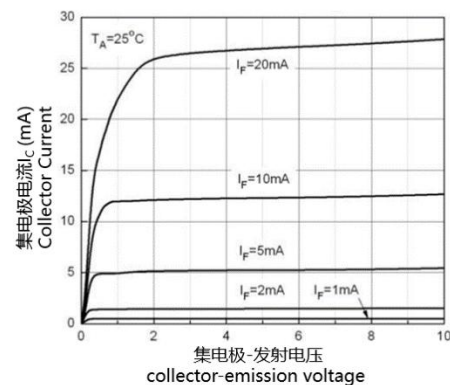

图8 集电极暗电流 vs 环境温度曲线图

Fig.8 Collector Dark Current vs. Ambient Temperature Curve

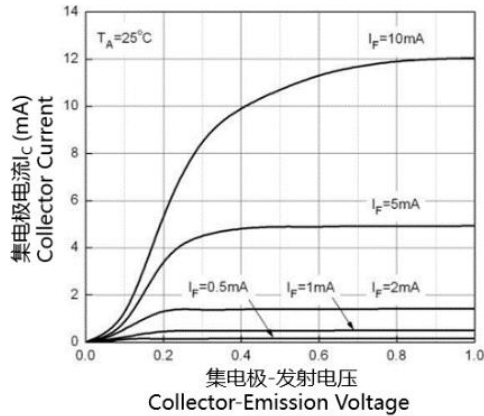

图9 集电极-发射极饱和电压 vs 环境温度曲线图

Fig.9 Collector-Emitter Saturation Voltage vs. Ambient Temperature Curve

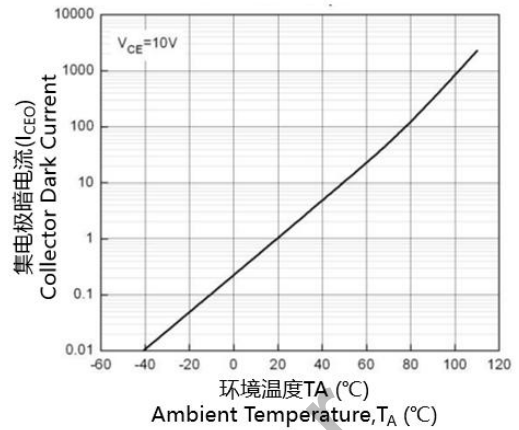

图10 响应时间 vs 负载电阻曲线图

Fig.10 Switching Time vs. Load Resistance Diagram

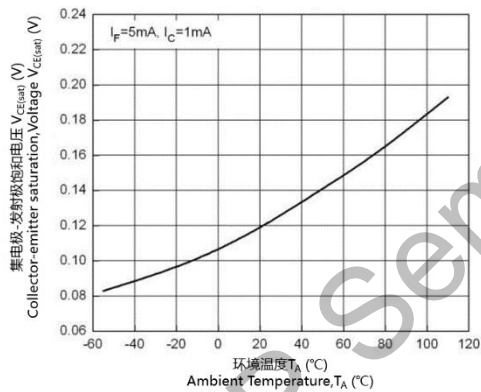

图11 开关时间测试电路及波形

Fig.11 Switching Time Test Circuit & Waveforms

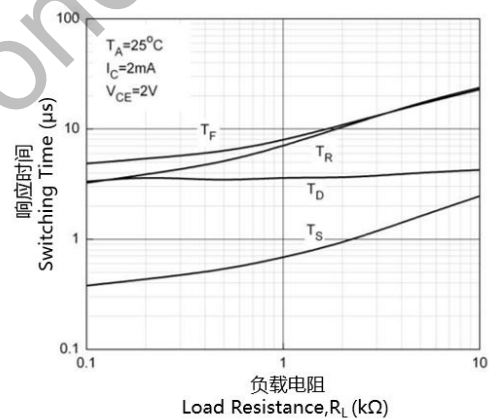
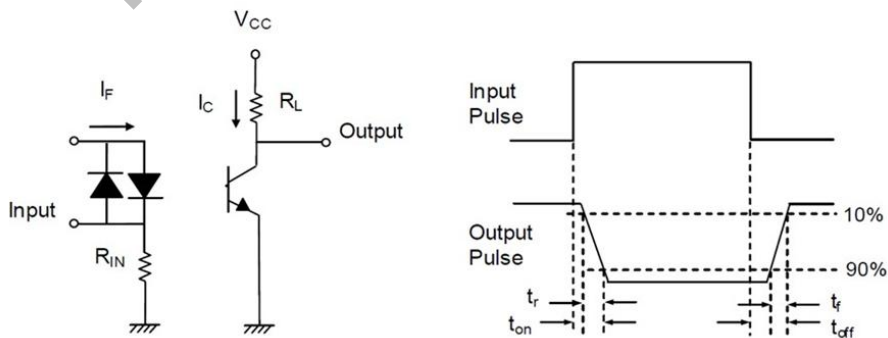

## 9. 订单信息 Order Information

- 零件编号 Part Number

### KTP3H4X-Y-W

#### 附注(Notes):

X = 表示CTR等级(A、B或无) CTR Rank (A、B or none)

Y = 载带和卷轴包装方式(TA)

Tape and reel option (TA)

W = 表示内部标识(有或无)

Indicates internal identification(with or without)

## 10. 封装尺寸(单位:毫米) Package Drawing(Unit:mm)

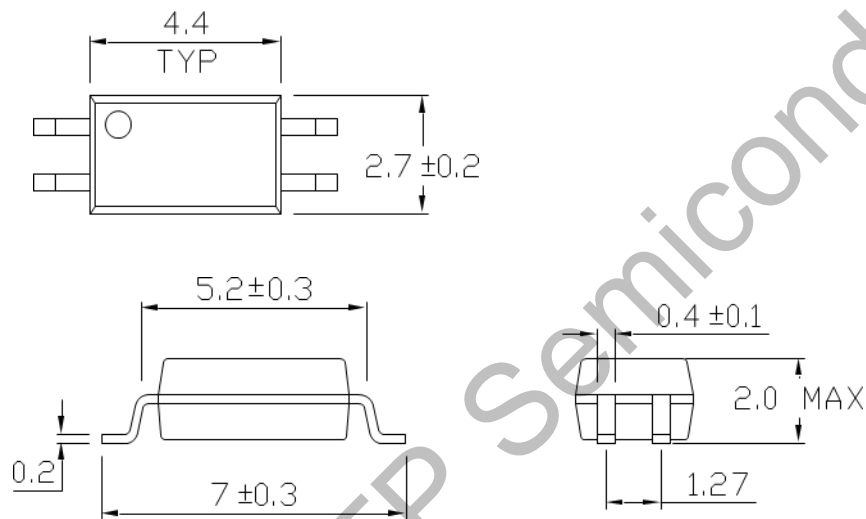

- 表面贴装引线框架及推荐焊盘布局 Recommended pad layout for surface mount leadform

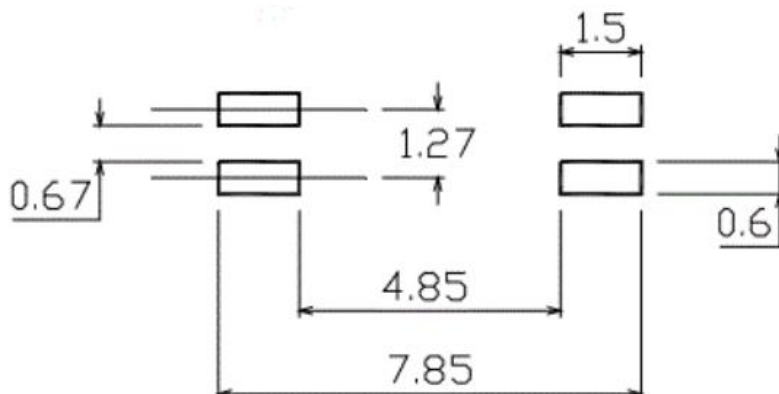

## 11. 焊接温度曲线 Temperature Profile Of Soldering

### • 回流焊温度曲线 Reflow soldering

建议在下面所示的温度和时间分布条件下, 进行一次回流焊作业, 不得超过三次

One time soldering reflow is recommended within the condition of temperature and time profile shown below. Do not solder more than three times.

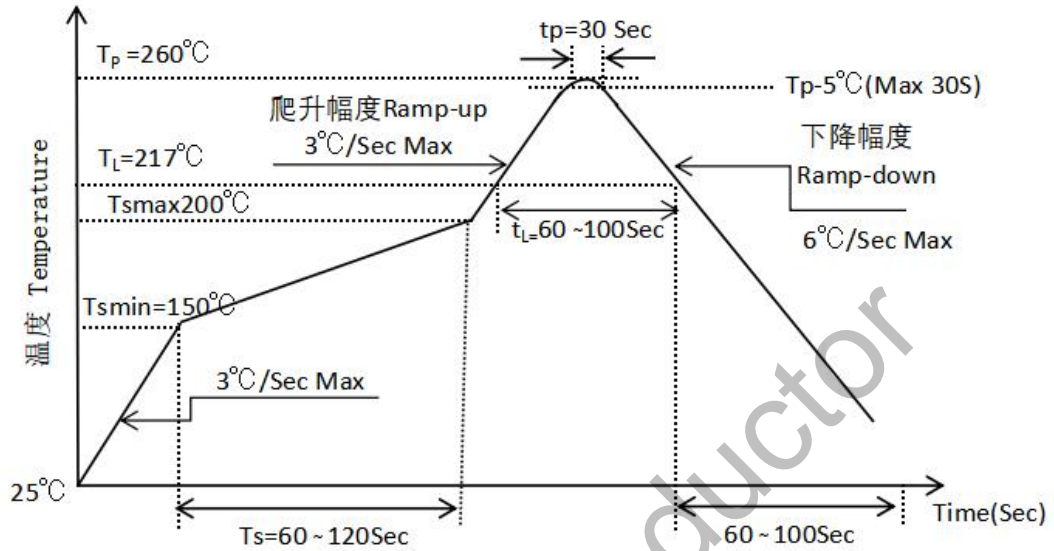

项目 Item	符号 Symbol	最小值 Min.	最大值 Max.	单位 Unit
预热温度 Preheat Temperature	$T_s$	150	200	°C
预热时间 Preheat Time	$t_s$	60	120	s
升温速率 Ramp-Up Rate ( $T_L$ to $T_P$ )	-	-	3	°C/s
液相线温度 Liquidus Temperature	$T_L$	217		°C
高于液相线温度( $T_L$ )的时间 Time above Liquidus Temperature $T_L$	$t_L$	60	100	s
峰值温度 Peak Temperature	$T_P$	-	260	°C
$T_c$ 在( $T_P-5$ )和 $T_P$ 之间的时间 Time During Which $T_c$ Is Between ( $T_P-5$ ) and $T_P$	$t_p$	-	30	s
降温速率 Ramp-down Rate( $T_P$ to $T_L$ )	-	-	6	°C/s